

Kenmore

INSTRUCTIONS

Introduction	1-3
Assembly	4-10
Operating Instructions	11-15
Appendix	16-17

MODEL 1570 ZIG ZAG SEWING MACHINE



TABLE OF CONTENTS

Section I Knowing Your Sewing Machine

Identifying Parts	2, 3
Installing and Connecting Machine	4
Converting to Free-arm Sewing	5
Winding the Bobbin	6
Threading Bobbin Case	7
Threading-Top Thread	8, 9

Using the Controls

Top Tension Control	10
Adjusting Top Tension	11
Stitch Length Control	12
Stitch Width Control	13
Reverse Stitch Control	14
Special Stitch Variegator	14
Special Stitch Dial	15a, b, c, d, e
Pressure Regulator	16
Darning Plate	17
Sewing Light	17
Seam Guide	18
Presser Foot Lever	18

Accessories

Needles	19
Needle, Thread, Fabric Chart	20
Presser Feet	21

Section II Starting to Sew

Garment Construction Stitches

Straight Stitching	2, 3
Fastening A Seam	3
Zigzag Stitching	4
Straight Stretch Stitching	5a
Rick-Rack Stretch Stitching	5b
Smocking Stretch Stitching	5b
Overcast Stretch Stitching	5c
Elastic Stretch Stitching	5c

Special Finish Stitches

Blind Hemming	6
Satin Stitching	7
Appliqueing	7
Buttonholing	8, 9
Button Sewing, Bar Tacking	10
Mending	11
Darning	11
Zipper Application	12
Decorative Stitches	13
Scallop Stitch, Arrow Head Stitch	14
Diamond Stitch, Domino Stitch	15
Free Arm Sewing	16

Section III Checking Performance Problems

Section IV Caring For The Machine

Cleaning Feed Dogs and Shuttle	1, 2
Oiling Under Top Cover Plate	3
Oiling Underside	4
Oiling in Face Cover Plate	5
Parts List	6, 7

Knowing Your Sewing Machine

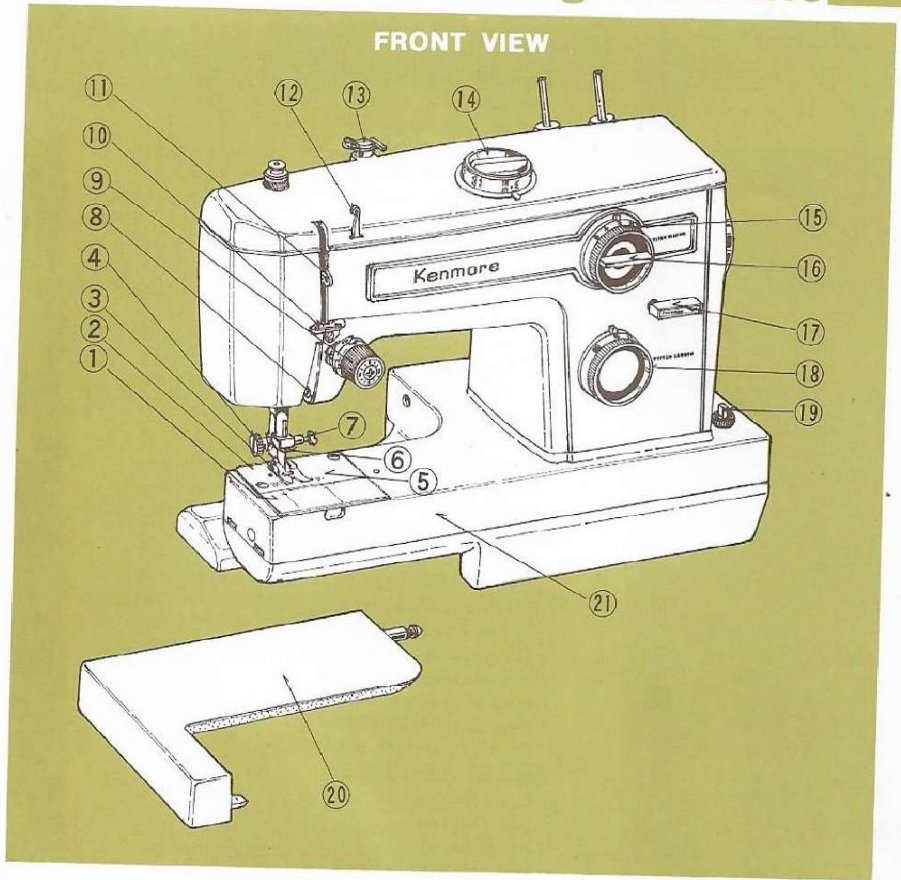

1. Shuttle Cover Plate
2. Needle Plate
3. Feed Dogs
4. Presser Foot Screw
5. Seam Guide Lines
6. Thread Guide
7. Needle Clamp Screw
8. Face cover Thread Guide
9. Top Thread Tension Control
10. Front Thread Guide

11. Thread Take-Up Lever
12. Top Thread Guide
13. Rear Thread Guide
14. Special Stitch Dial
15. Stitch Width Control
16. Special Stitch Variegator
17. Reverse Stitch Control
18. Stitch Length Control
19. Light and Power Switch
20. Extension Table
21. Free Arm

BACK VIEW

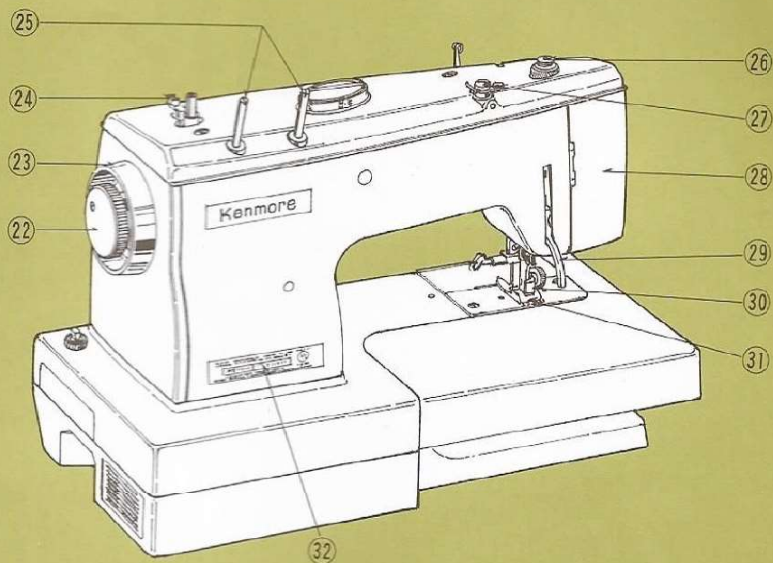

- 22. Clutch Knob
- 23. Hand Wheel
- 24. Bobbin Winder
- 25. Thread Spool Pins
- 26. Pressure Regulator
- 27. Bobbin Winder Tension Disc

- 28. Face Cover Plate
- 29. Presser Foot Lever
- 30. Thread Cutter
- 31. Presser Foot
- 32. Nomenclature Plate

INSTALLING MACHINE

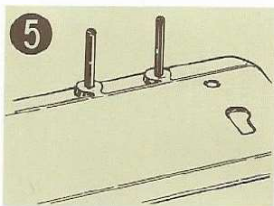
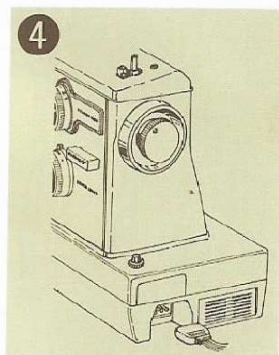
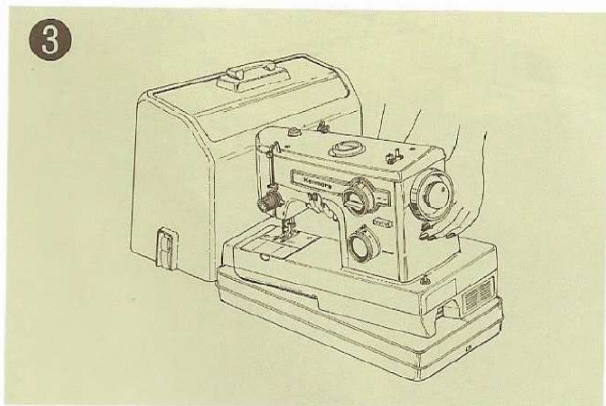
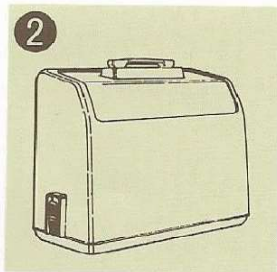
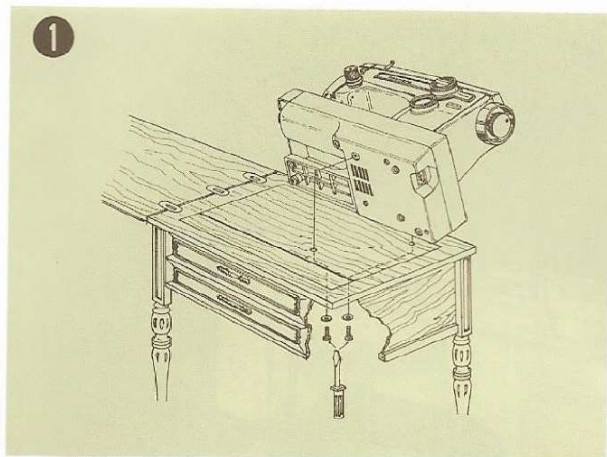

1. To install the machine in cabinet, position machine head on cabinet platform so that holes on bottom of machine match those on boards. Insert washers and screws and tighten into place. (Fig. 1)
2. To install machine in portable carrying case, simply slip machine into base, making certain the machine and the words **Front** in the case face you. (Fig. 2)
Place cover on machine with words **"Sears"** on handle facing you.
3. Push the speed control plug onto three-prong connector. Plug machine cord into any 110—120 volt wall outlet. Turn on power by pushing light and power switch. (See Fig. 4)
4. Screw spool pins firmly into place with a screwdriver.
Place nylon discs on spool pins. Discs and pins are packed in the accessory box.

The case slopes in the same direction of the machine. (Fig. 3)

CONVERTING TO FREE-ARM SEWING

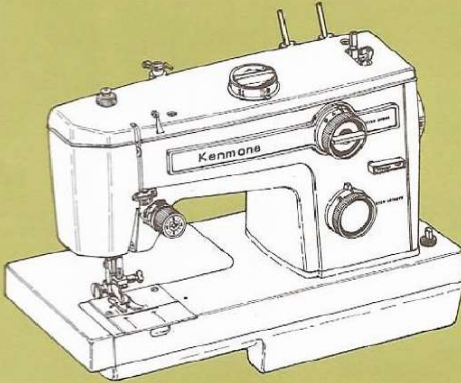

(Fig. 1)

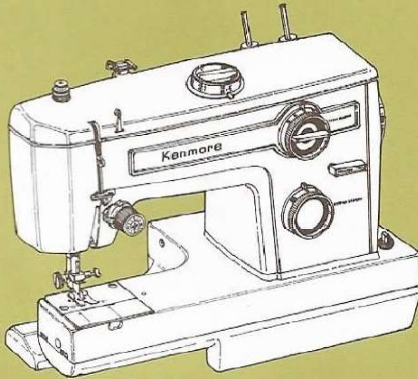

(Fig. 2)

1. Remove the table from the machine by pulling the base to the left. (Fig. 1, 2)
2. To replace the table, simply slide it along the free arm to its original position. (Fig. 1)

WINDING THE BOBBIN

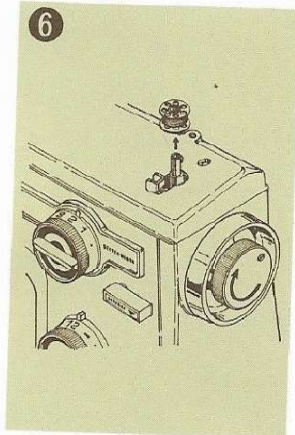
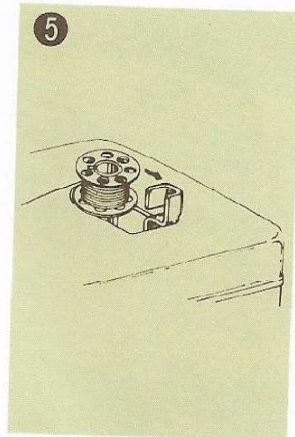
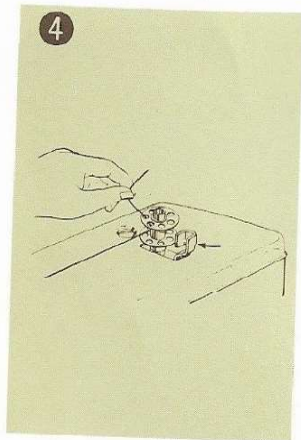
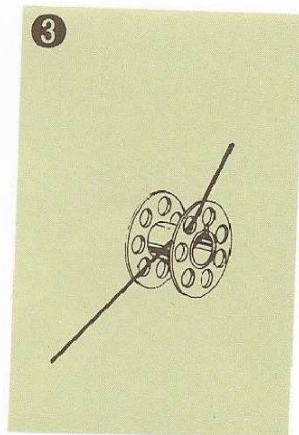
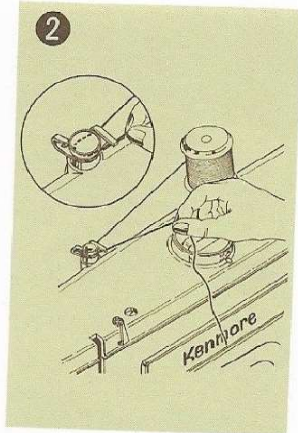
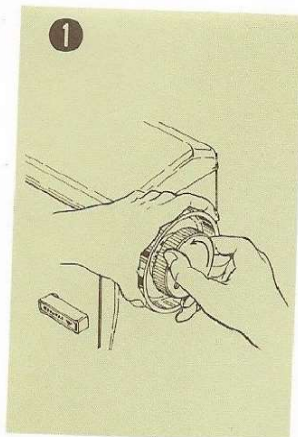

1. Release clutch by turning clutch knob toward you.
2. Draw thread from spool through bobbin winder tension discs as shown.
3. Pull end of thread through hole in bobbin as shown.
4. Place bobbin onto bobbin winder shaft with end of thread coming from the top of the bobbin.
5. Start machine. Wind thread until bobbin winder latch releases.
6. Tighten clutch knob and remove bobbin.

Push bobbin winder latch against bobbin until it clicks. Holding onto end of thread, start machine. When bobbin is slightly filled, snip off end of thread.

Two spool pins have been included with this machine to aid in bobbin winding. By placing a spool of thread on the second spool pin, you may wind your bobbin without unthreading the machine.

THREADING THE BOBBIN CASE

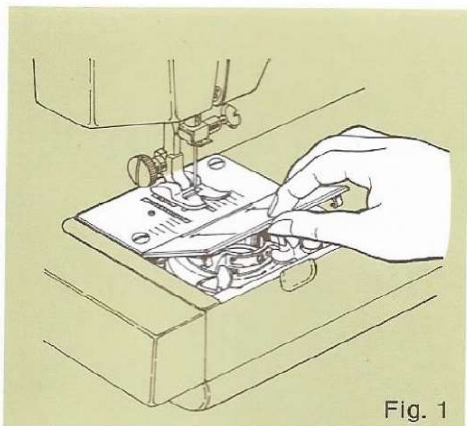

Fig. 1

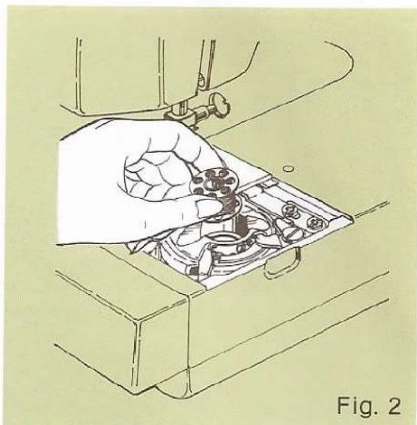

Fig. 2

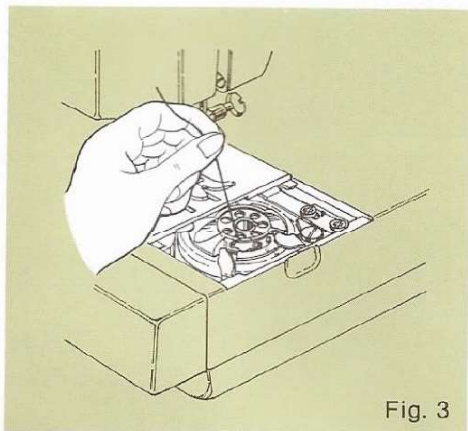

Fig. 3

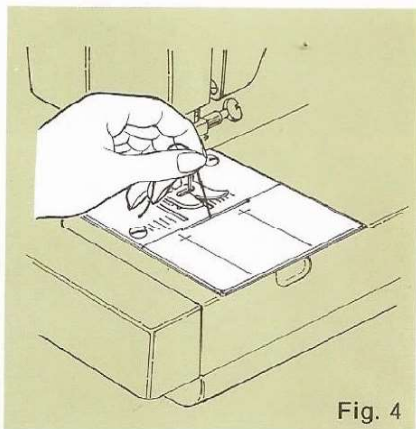

Fig. 4

1. Turn hand wheel toward you to raise needle to highest position.
2. Remove bobbin cover plate—just lift up the front and it slips right out. Fig. 1
3. Place the full bobbin in bobbin case with the thread coming off in a counter-clockwise direction. Fig. 2
4. Pull thread into slot (a) of bobbin case. Pull thread from right to left and back through slot (b). Fig. 3
5. Draw about 4 inches of thread back; replace the bobbin cover plate with this thread coming out as shown. Fig. 4

THREADING OF TOP THREAD

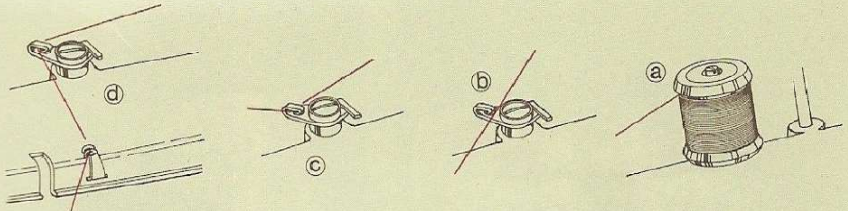

Fig 1- (a) (b) (c) (d)

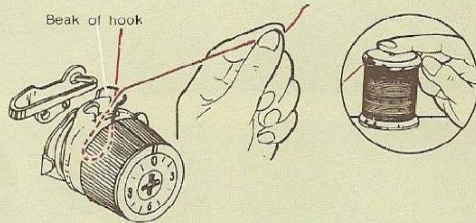

Fig 2

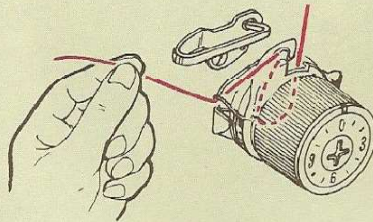

Fig 3

1. Place thread on spool pin as shown, with thread coming from the back of the spool (Fig. 1-a). Draw thread through the rear thread guide (Fig. 1-b, 1-c). Pass thread through top thread guide (Fig. 1-d).
2. Holding the spool with the right hand, pull the thread through the tension discs. The spring wire loop should be pulled up until the thread passes beyond the beak of the hook. Fig. 2.
3. After the thread has slipped into the hook, allow the spring wire to return to position by releasing the thread spool. Fig. 3.

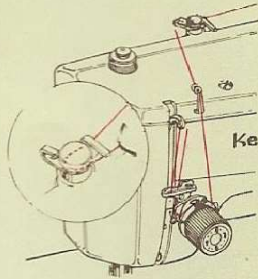

Fig 4

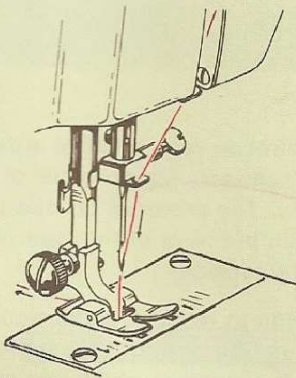
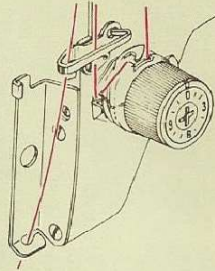

Fig. 5.

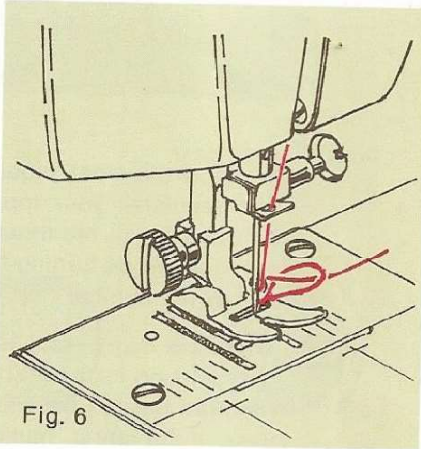
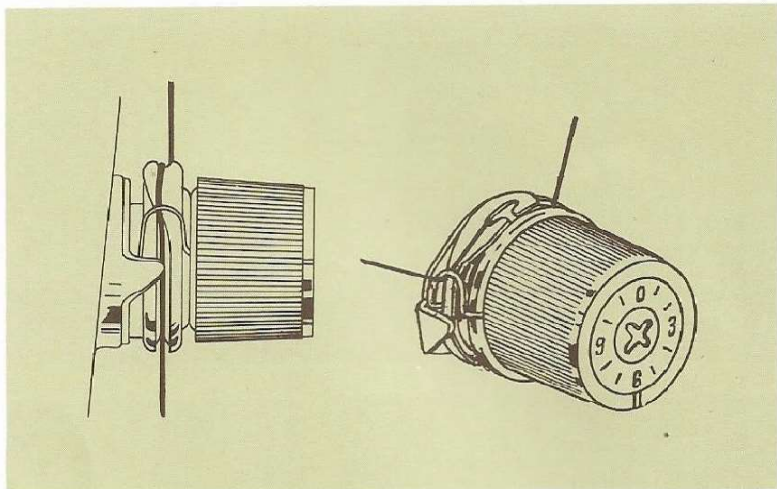

Fig. 6

4. Continue threading through the front thread guide, take-up lever, and down through path shown in Fig. 4 and 5.
5. Always thread needle in direction as shown in Fig. 5.
6. Holding the needle thread with left hand, rotate hand wheel toward you for one complete turn. This brings the bobbin thread up to the surface. With right hand, reach into this loop of thread with a small screwdriver and pull loop free. Three or four inches of both threads should then be pulled to rear of needle. Fig. 6.

CONTROLS

TOP TENSION CONTROL



Probably the most important control on your machine is this one that regulates your top thread tension. It consists of discs between which the thread passes. The pressure on these discs is regulated by turning the dial on the front of the control. The higher the number, the tighter the tension.

There are many reasons for having to reset your tension. The best tension for one fabric may not be correct for another. The required tension depends upon the stiffness of the fabric, thickness of the fabric, numbers of layers of fabric being sewn, as well as the type of stitch you are making.

It is best to test the stitching on a scrap of the fabric you are using before starting to make a garment. To adjust for the correct stitch, see next page.

ADJUSTING TOP TENSION

A perfect stitch will have threads locked between the two layers of fabric with no loops on top or bottom.

1



PROBLEM

REMEDY

Upper thread too tight

Decrease Tension

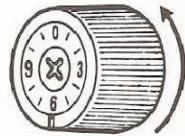
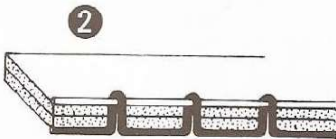

Upper thread too loose

Increase Tension

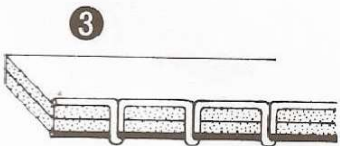

STITCH LENGTH CONTROL



The stitch length control regulates the length of the stitch you select. THE HIGHER THE NUMBER - THE SHORTER THE STITCH.

The stitch setting you use will be determined by the thickness of the fabric you are sewing. A longer stitch setting should be used for thicker fabric or more layers of fabric.

The middle range of the control is the 10-12 stitch per inch range which is the most commonly used.

A basting stitch is made by using the **B** setting to make the longest possible stitch.

STITCH WIDTH CONTROL

The outer rim of this control regulates the width of the stitch you select.

THE HIGHER THE NUMBER, THE WIDER THE STITCH.

You may vary your zigzag stitch width by adjusting this control to the setting you desire.

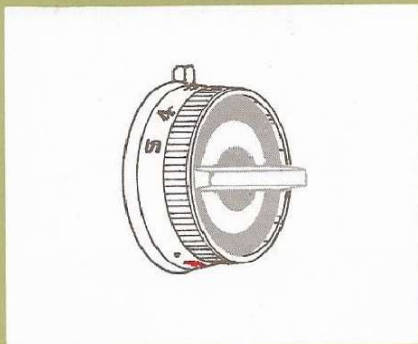

This control must be on the Red Dot in order to do straight stitching.

Before turning control, make sure needle is above fabric.

You will note a simulated buttonhole on the stitch width control. This setting is used when sewing a buttonhole as explained in next section pages 8 and 9.

REVERSE STITCH CONTROL

It is best to begin and end seams with a few stitches taken in reverse. This is called back tacking. Back tacking fastens the end of the seams firmly and prevents raveling.

When reverse stitching is needed, simply press and hold the control down during sewing. The fabric will immediately start feeding backward and seam will be fastened.

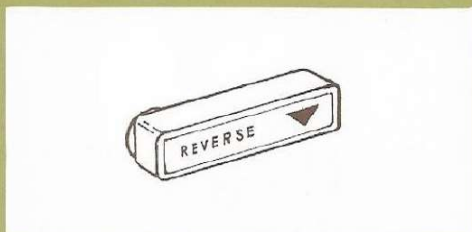

Reverse Stitch Control

SPECIAL STITCH VARIEGATOR

The center portion of this control gives you the means of varying the stitches on the Special Stitch Dial. When the control is turned with the red mark on top the machine sews forward only. When the control is turned with black mark on top the forward designs are varied by machine sewing in a forward and reverse manner.

Carefully read directions given in the next section of the book in order to accomplish the various stitches correctly.

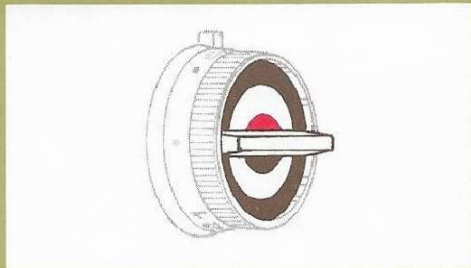

Special Stitch Variegator

SPECIAL STITCH DIAL

There are certain types of utility stitches you will use often in your home sewing. This control enables you to just dial the stitch you need for the task at hand.

All stitches marked in black on the dial must be sewn with the Special Stitch Variegator set with the Black mark on top.

To make the stitches marked in red on this dial, the Special Stitch Variegator must be set with the Red mark on top.

Important:

Before turning the control, make sure needle is above fabric and Stitch Width Control is at red dot.

REGULAR STITCH SETTING

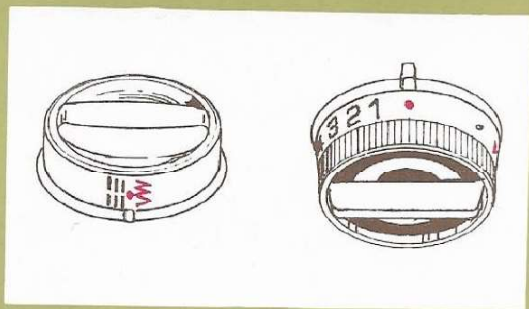

The setting illustrated above is the one used for most of your stitching. At this setting you may straight stitch, stretch stitch and make a simple zig zag stitch. As each stitch is dependent upon the settings of your other controls, carefully read the directions in the next section of the book for the various stitches.

BLIND STITCH OR OVERCAST STRETCH SETTING

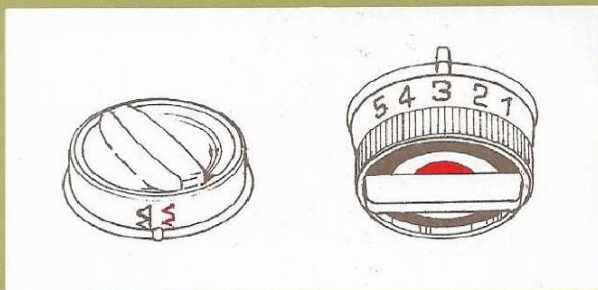

Blind hems are made by using the setting shown above with the Stitch Variator set with the Red mark on top. When the Variator is set with the Black mark on top, overcast stretch stitching is made with a forward and reverse action of the machine.

MENDING STITCH SETTING

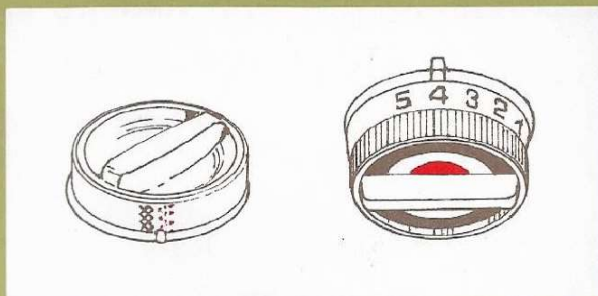

You will find that much of your sewing is in the mending category. For this reason you have been provided with a stitch for the repair of tears. It is accomplished with the above illustrated setting and the Special Stitch Variator is set with the Red mark on top.

When the Special Stitch Variator is set with the Black mark on top a Smocking Stitch results. For directions see the next section of the book.

BUTTONHOLE STITCH SETTING

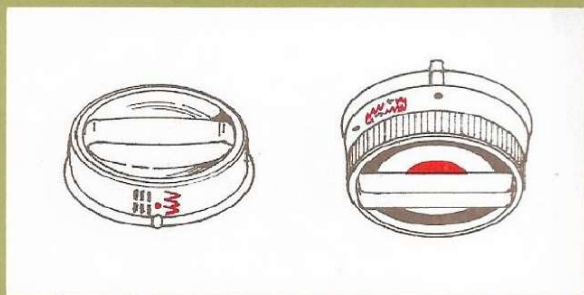

Buttonhole stitching is started with the Special Stitch Dial set as shown.

Complete instructions for making a buttonhole are given in the next section of the book.

SCALLOP STITCH SETTING

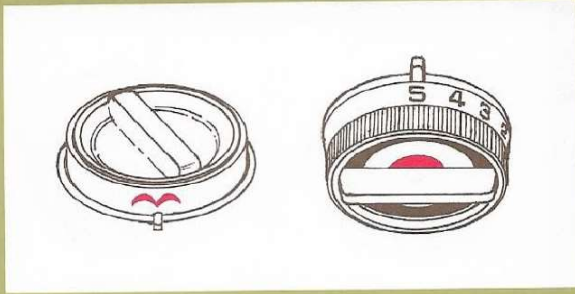

The setting illustrated above is used for scallop finished edge and special edge finishing.

See next section of this book for detailed use of the stitches.

DIAMOND STITCH SETTING

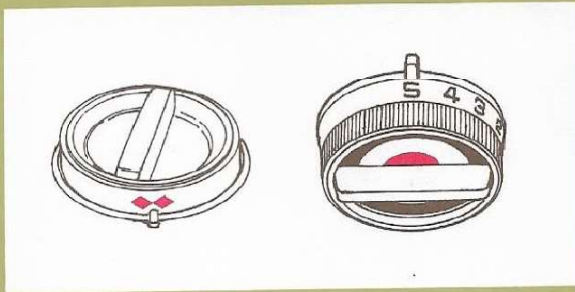

Diamond stitch is made by using the setting illustrated above with the Special Stitch Variegator set with the Red mark on top.

DOMINO STITCH

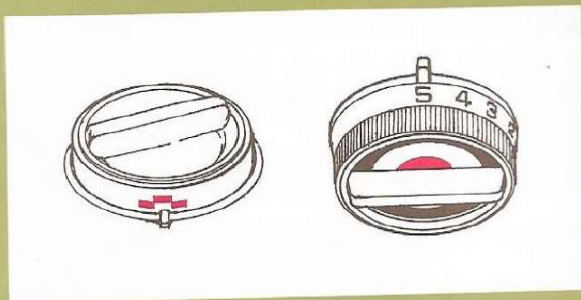

Domino stitches are decorative. To sew, set the machine as indicated in settings shown above.

ARROW HEAD STITCH SETTING

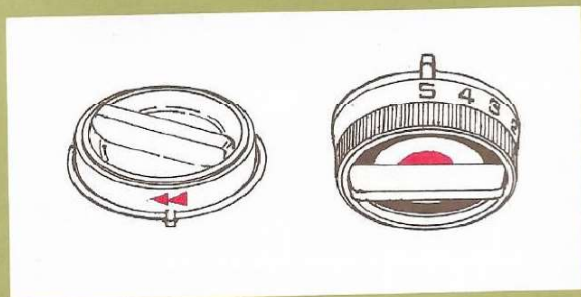

Arrow stitch is made by using the setting illustrated above with the Special Stitch Variegator set with the Red mark on top.

OTHER ADJUSTMENTS OF MACHINE IN SEWING

In addition to the obvious controls of your machine there are other small regulators and controls to aid you in using your sewing machine.

PRESSER FOOT PRESSURE REGULATOR

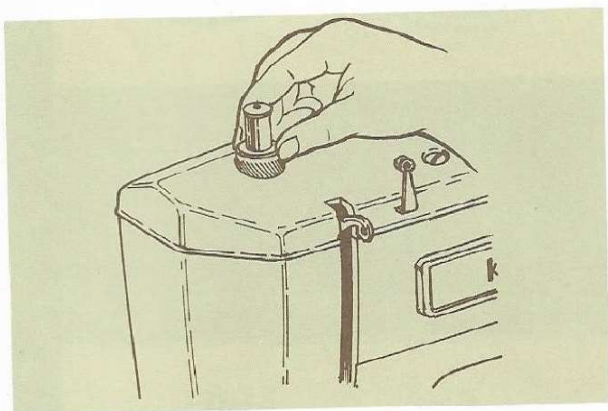

Push down outer ring of presser foot pressure regulator (See above illustration). This will release pressure of presser foot. To increase pressure, push down inner pin until suitable pressure is obtained. For ordinary sewing, the inner pin should be all the way down.

Insufficient pressure may cause poor feeding of the fabric, skipped stitches, or difficulty in guiding the fabric.

When sewing multiple thickness or heavy fabric reduce the pressure. Increase pressure when sewing lighter weight fabrics. If feed dog or presser foot marks appear on the fabric, reduce the pressure.

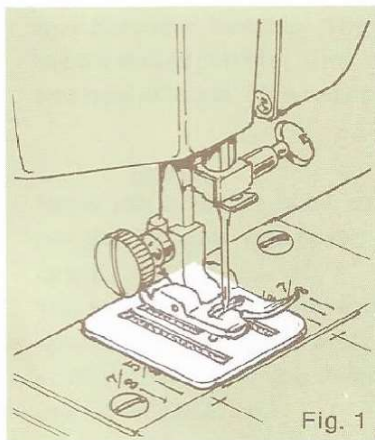

Fig. 1

DARNING PLATE

When you need to feed the fabric by hand as in darning, or sewing on buttons, attach the darning plate over the needle plate as shown in Fig. 1. Be sure you have the needle raised to its highest position when doing this.

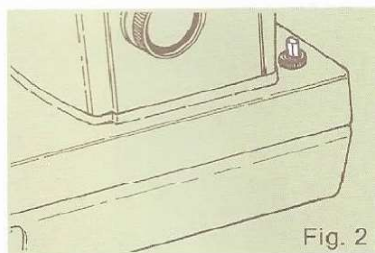

Fig. 2

SEWING LIGHT

The light and power switch shown in Fig. 2 provides the electric current for the motor as well as the light. In order to operate the machine this switch must be on.

To turn on the light, depress the switch. If you are interrupted while sewing and must leave the machine unattended, just turn off the switch and the machine cannot be started accidentally.

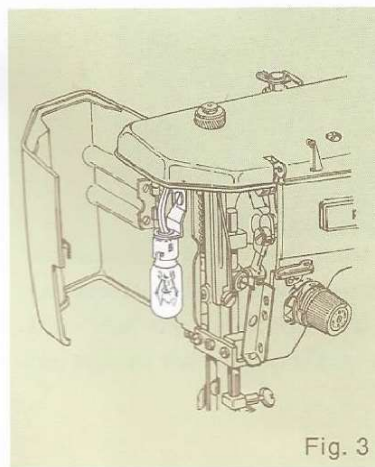

Fig. 3

The sewing light is located inside the face cover plate as shown in Fig. 3. To replace the bulb, turn light off, and swing the face cover plate open. Push up on the bulb slightly and turn bulb to the left.

Remove bulb from socket. Push in new bulb and turn to the right.

SEAM GUIDES

Seam Guides are marked on either side of the needle plate to aid you in guiding your fabric.

PRESSER FOOT LEVER

To aid you in the placement of heavy fabrics under the presser foot, the presser foot lever can raise the foot beyond the normal "UP" position.

This is also an aid in changing your presser feet.

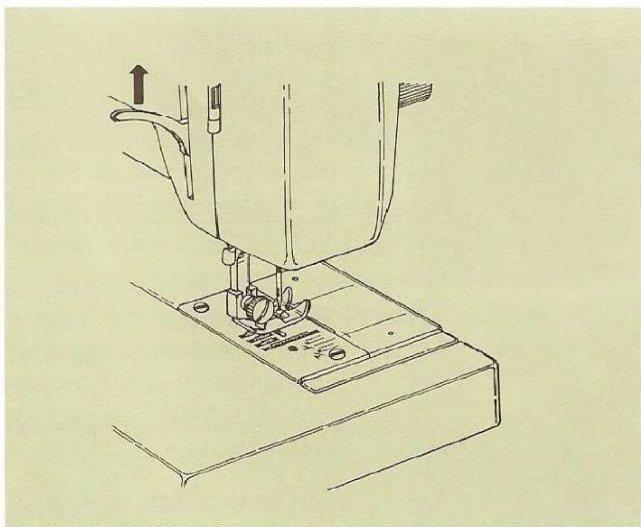

NEEDLES

Use Kenmore Needles. The size of the needle should conform to the size of thread and type of fabric. (See next page).

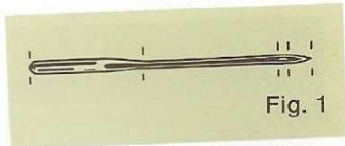
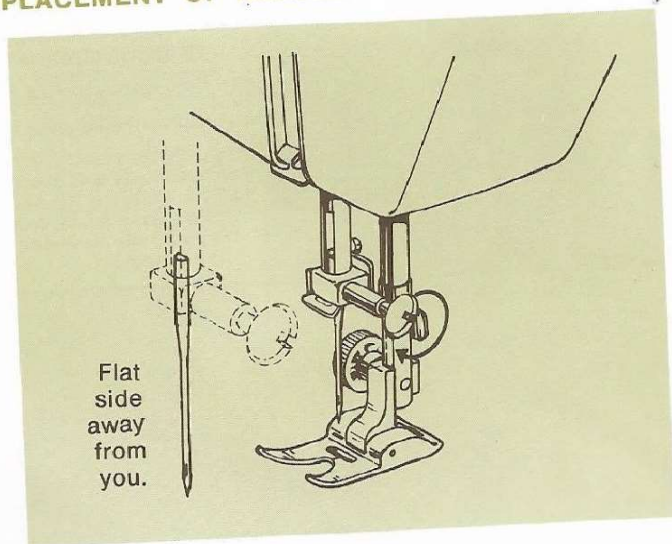

Fig. 1

Never use a bent or blunt needle. Fig. 1 shows you the exact length of your needle. Be sure you never use one in your machine that is not this exact length.

You will find among your accessories "Q NEEDLE"™ with blue shank. This special needle is to be used when sewing certain knits and certain difficult synthetic fabrics. If you experience skipped stitches in any of your sewing, use "Q NEEDLE"™.

PLACEMENT OF NEEDLE



Raise needle bar to its highest position by turning the hand wheel toward you. Loosen the needle clamp screw. Holding the needle with the flat side away from you, slip the needle into the needle bar. When it is in as far as it will go, tighten the needle clamp screw with a screwdriver.

NEEDLE, THREAD, AND FABRIC CHART

THREAD SIZE	NEEDLE SIZE	FABRIC
POLYESTER CORE/COTTON WRAP FINE MERCERIZED COTTON POLYESTER SYNTHETIC SILK A	9 or 11	Lightweight: Batiste, Dimity, Chiffon, Silks, Synthetic Jerseys, Fine Lace, Organza, Crepe, Taffetta, Voile, Organdy
50 MERCERIZED COTTON POLYESTER SYNTHETIC SILK A	14	Medium Weight: Cotton, Cotton Blends, Percale, Gingham, Shantung, Pique, Søersucker, Satin, Knits, Vinyl, Suitings, Linen, Wool Crepe, Leather
50 MERCERIZED COTTON MERCERIZED HEAVY DUTY POLYESTER SYNTHETIC SILK A	14 or 16	Medium Heavy Weight: Corduroy, Denim, Wool, Sailcloth, Wool Flannel, Gabardine, Velvets, Leather
HEAVY DUTY MERCERIZED COTTON POLYESTER SYNTHETIC SILK A	18	Heavy Weight: Coatings, Upholstery, Cotton Duck, Heavy Twills, Canvas
SILK BUTTONHOLE TWIST	16, 18 or "Q NEEDLE"™	Decorative Top-stitching on all
POLYESTER SYNTHETIC 50 MERCERIZED COTTON	"Q NEEDLE"™	Synthetic Knits and Stretch Fabrics: Polyester Double Knits, Nylon Tricot, Jersey, Stretch Terry, Spandex, Cire Tricot

ACCESSORIES

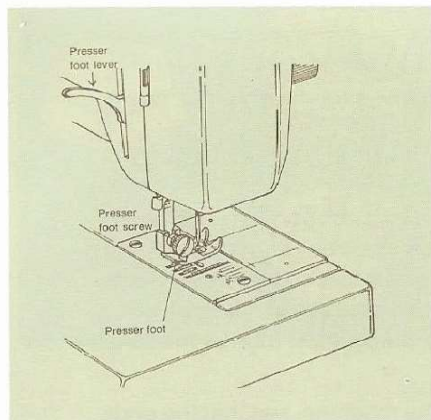

PRESSER FEET

The various presser feet that come with your Kenmore Sewing Machine are designed to help you to do every kind of sewing easily and perfectly.

To change the presser foot:

1. Raise the needle to its highest position by turning hand wheel towards you.
2. Raise the presser bar to its highest position by lifting the presser foot lever.
3. Loosen the presser foot screw. (You do not need to remove the screw)
4. Choose the proper foot. Insert from the front.
5. Tighten the screw using the large screwdriver to make certain the foot is secure.

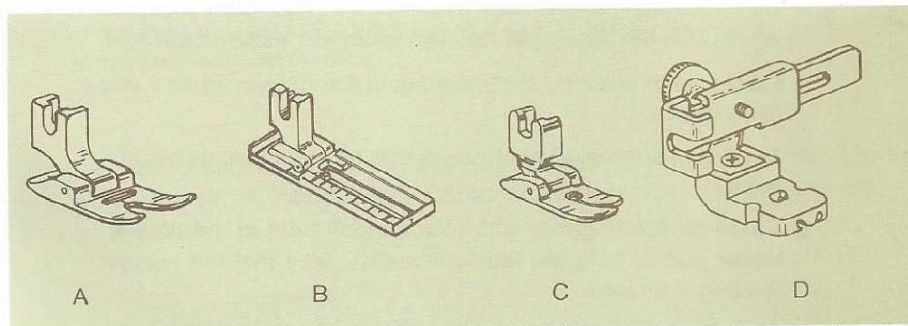

You have been given a variety of presser feet:

- A. Zigzag Stitch Foot
- B. Buttonhole Foot
- C. Straight Stitch Foot
- D. Zipper Foot

Starting to Sew

Now that you are familiar with the controls on your machine and with the accessories provided for the machine, you are ready to start to sew with your new Kenmore sewing machine. Below are some good habits to follow each time you sit down to sew:

1. Test the needle - it should be straight, properly set and sharp on the point. It should be the correct size for the fabric and thread being used. Do not be afraid to change your needle frequently. Many of the new fabrics made of synthetic blends tend to dull the needles more easily than fabrics made of natural fibers.
2. Before placing the material on the machine, see that the ends of the threads have been drawn about 4 inches to the rear of the machine. Hold on to threads during the sewing of the first 3 or 4 stitches of the seam.
3. Test the machine stitch on a scrap of fabric you plan to use. The fabric should be double thickness. Adjust the machine for the length of stitch and tension suitable to your fabric.
4. Fabric should be placed under the presser foot with the bulk of the material to the left of the needle and the right edge of the material placed on the 5/8" seam marking on the needle plate when making a simple seam.
5. Run the machine at a slow even speed. The more pressure you put on the speed control, the faster the machine will sew.
6. Fasten each seam by back tacking at the beginning and end of the seam.
7. Always finish sewing each seam with the needle at its highest point.
8. Guide the fabric gently with your hand in front of the needle. Never pull or hold the fabric in such a way that the normal feeding is altered.
9. When turning the hand wheel manually, always turn it toward you.

GARMENT CONSTRUCTION STITCHES

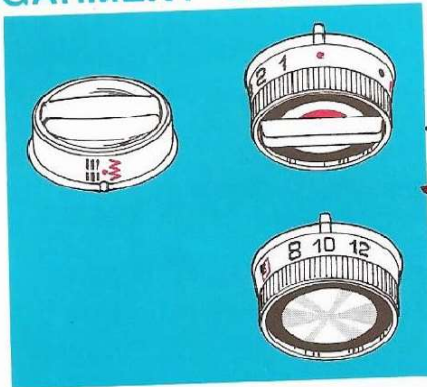

STRAIGHT STITCHING

← *important*

SETTINGS:

Special Stitch Dial — 

Special Stitch Variegator — Red mark on top.

Stitch Width Control — Red Dot

Stitch Length Control — 8 to 12.

Straight Stitch Foot

Set your machine just as shown in the illustration in order to straight stitch. It is important that each dial have the above setting. Before setting turn hand wheel toward you, so that needle is above fabric.

You will find in garment construction that you are doing two types of sewing — temporary and permanent.

1. Temporary stitching — Usually the longest stitch possible and often done on a single layer of fabric. The various types of temporary stitching are:

- Basting
- Stay stitching
- Guide line marking

2. Permanent stitching—This is the actual stitching that holds the garment together. Much of this stitching is visible on the outside of the garment and therefore must be good looking.

The best length stitch to use for medium weight fabrics is 10–12 stitches per inch. This is in the middle range of the Stitch Length Control.

You must remember to lengthen the stitch for heavier fabrics, multiple layers of fabric and thicker seams. Some of these seams are:

- Common two layer seams
- Curved two layer seams
- Top stitched three layer seams
- Top stitched four layer seams

When you have two seams crossing each other with considerable thickness, sew slowly and carefully so seam will be strong as possible in this area.

FASTENING A SEAM (Backtacking)

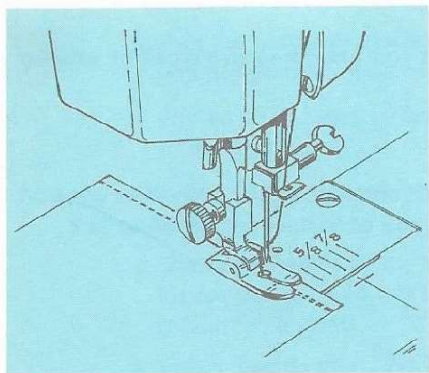

Be sure both threads are drawn back under the presser foot. Lower needle into fabric about 1/2 inch from beginning of seam. Depress reverse stitch control and stitch in reverse until needle reaches beginning of seam. Release reverse stitch control and complete seam. When you reach the end, depress reverse stitch control and sew back over 1/2 inch of completed seam.

ZIGZAG STITCHING

SETTINGS:

Special Stitch Dial — III:3

Special Stitch Variegator — Red mark on top

Stitch Width Control — 2 to 5

Stitch Length Control — Any setting except Black Dot Zigzag Stitch Foot

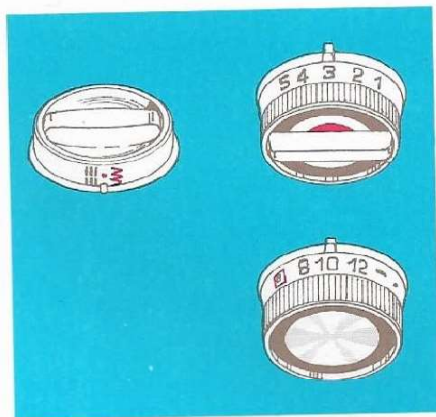

This type of stitching greatly expands the use of your machine. This is the feature that enables you to overcast seams, applique and monogram.

Simply use the settings indicated in the illustration for the simple zigzag. Follow directions given below and in the following pages for more specific uses.

OVERCASTING

This is one of the more frequently used zigzag stitches in garment construction. You may want to overcast along the raw edge of each seam allowance or fold the raw edge toward the garment and stitch.

Fig. 1 shows the raw edge finished. Fig. 2 illustrates the folded edge stitched.

Stitch so the needle pierces the fabric just short of the outside edge. Raw or worn edges of older garments can be overcast to prevent further raveling.

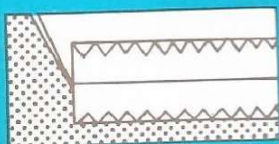

Fig. 1

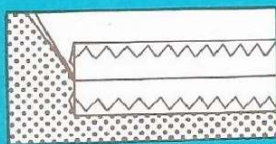
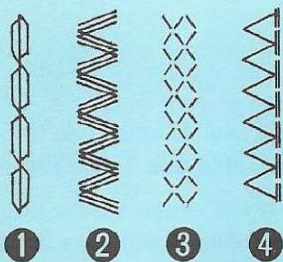

Fig. 2

STRETCH STITCHING

The stitches shown below are all for use with stretch and knit fabrics. These are special stitches built in to the machine for your quick selection.



1. Straight Stretch
2. Rick-Rack Stretch
3. Smocking Stretch
4. Overcast Stretch

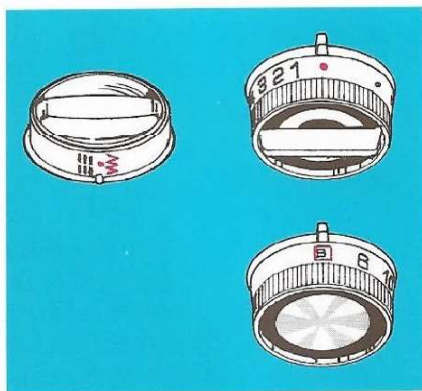

STRAIGHT STRETCH STITCHING

SETTINGS:

Special Stitch Dial —

Special Stitch Variegator — Black mark on top

Stitch Width Control — Red Dot

Stitch Length Control —

Straight Stitch Foot

Use this special stretch stitch with knitted fabrics and other fabrics that stretch. Sew as you do a regular straight stitch seam. The machine will make triple lock stitches back and forth which gives the stretch to the seam.

See illustration.

This stitch enables you to press open your seam as with any straight stitched seam. The seam will stretch with the fabric without breaking the thread.

This is also a good stitch to use on curved seams that will receive a great deal of strain when worn, such as in children's shorts and slacks as well as adult sport clothes.

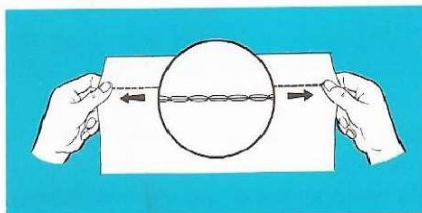

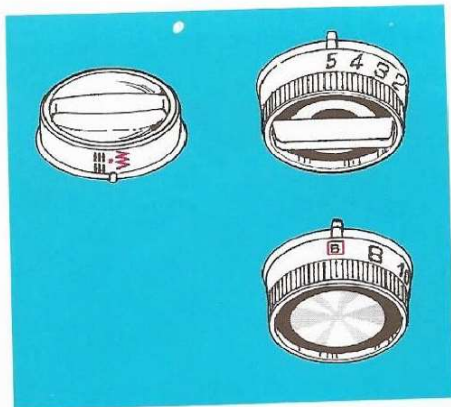

RICK-RACK STRETCH STITCHING

SETTINGS:

Special Stitch Dial —

Special Stitch Variegator — Black mark on top

Stitch Width Control — Any number 2 to 5

Stitch Length Control —

Zigzag Stitch Foot

Use this special stitch for all-purpose heavy duty sewing of stretch fabrics. Sew as you do a regular plain zigzag seam.

The machine will make triple lock stitches back and forth of a fixed stitch length, to give the stretch to seam.

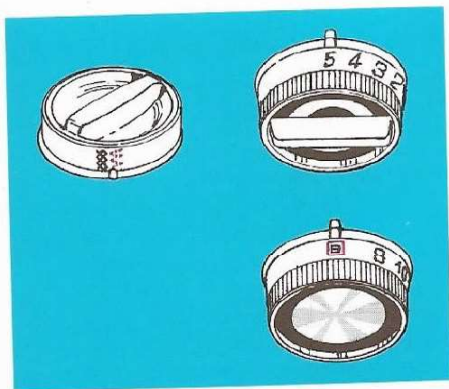

SMOCKING STRETCH STITCHING

SETTINGS:

Step 1. Make a straight line of gathers across the fabric that you wish to smock.

Step 2. Special Stitch Dial —

Special Stitch Variegator — Black mark on top

Stitch Width Control — 4 to 5

Stitch Length Control —

Zigzag Stitch Foot

With a narrow strip of fabric directly under the line of gathering, stitch over the gathers. The design will be a series of small diamonds.

When smocking a garment, the stitching should be done before the piece is sewn into the garment.

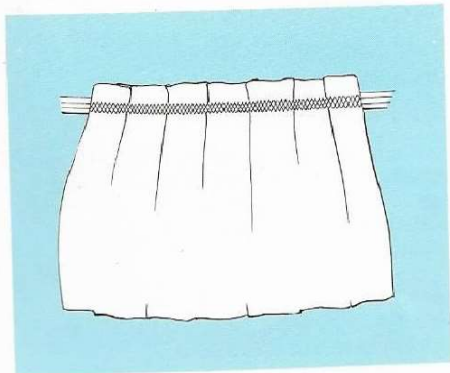

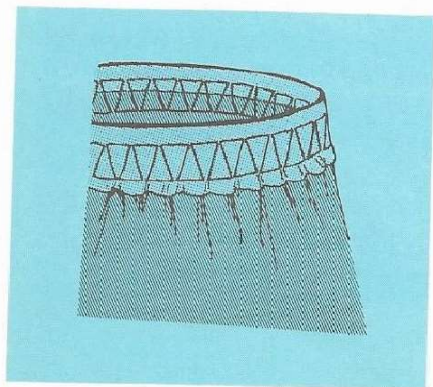
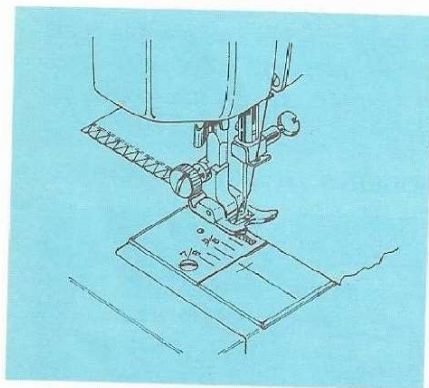
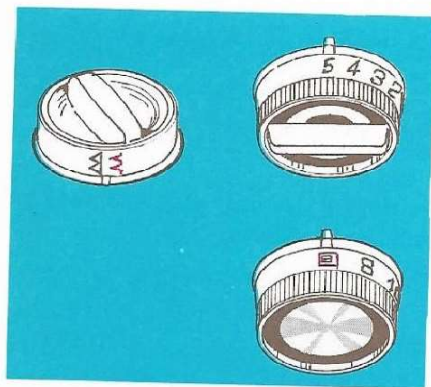

OVERCAST STRETCH STITCHING

SETTINGS:

Special Stitch Dial—

Special Stitch Variegator—Black mark on top

Stitch Width Control—3 to 5

Stitch Length Control—

Zigzag Stitch Foot

This is the same type of stitch used by the garment industry in making sportswear. It is used for seams of $3/8"$ to $1/4"$. The seam is formed and finished in one operation. It must be used when you are making swimwear, ski pants and other garments that require stretch.

Fig. 1 shows the raw edge finished.

Stitch so the needle pierces the fabric just short of the outside edge.

Raw or worn edges of older garments can be overcast to prevent further raveling.

ELASTIC STRETCH STITCHING

SETTINGS:

Special Stitch Dial—

Special Stitch Variegator—Black mark on top

Stitch Width Control—3 to 5

Stitch Length Control—

Zigzag Stitch Foot

This is a good stitch to use in making or repairing lingerie. The stitch is decorative as well as useful. Simply stitch the elastic into place around the waist of the garment, making sure that the elastic is evenly spaced. To do this mark the correct length piece into quarters and match these markings with center front and back of the garment as well as side seams.

SPECIAL FINISH STITCHES

After the basic construction of your garment is finished, there are still many finishing touches to be done. To aid your completion of your garment, the **Kenmore** has been designed to do the following tasks that formerly had to be done by hand.

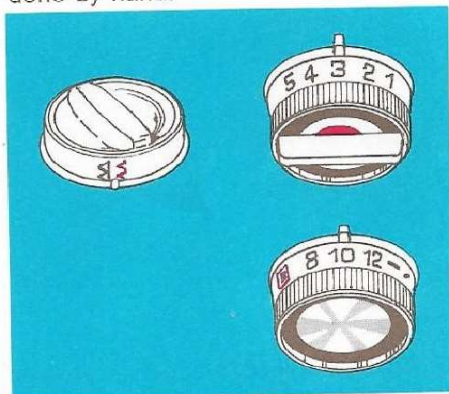

BLIND HEMMING

SETTINGS:

Special Stitch Dial — 

Special Stitch Variegator — Red mark on top

Stitch Width Control — 2 to 3

Stitch Length Control — about 8 to 12
Zigzag Stitch Foot

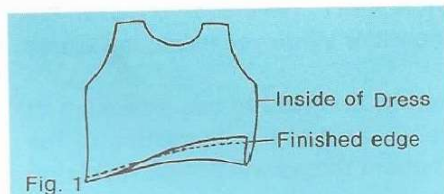

1. Finish edge of hem anyway you desire. Turn up hem appropriate width. Fig. 1

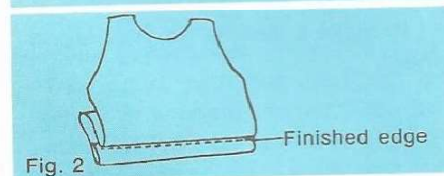

2. Fold garment away from hem leaving 1/8" of hem edge extending. Fig. 2

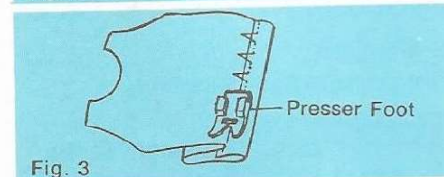

3. Place garment under presser foot in such a manner that straight stitches will be sewn on extended edge. The zigzag stitch should just catch the fold of the garment. Fig. 3

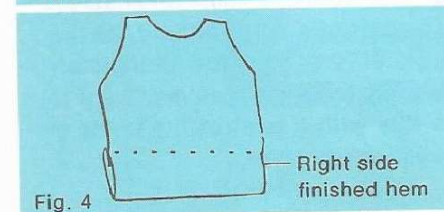

4. Press both sides of the finished hem. The right side of the garment will show only the blind stitches. Fig. 4

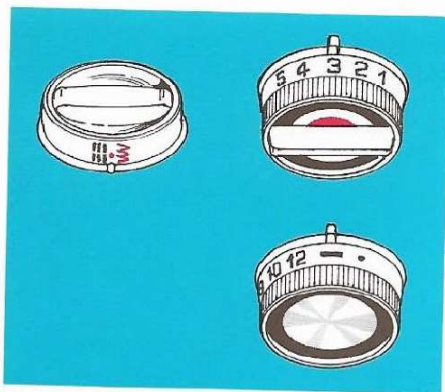

SATIN STITCHING

SETTINGS:

Special Stitch Dial— III W

Special Stitch Variegator—Red mark
on top

Stitch Width Control—Any number 2 to 5

Stitch Length Control— ■

Zigzag Stitch Foot

Closely spaced zigzag stitches are called satin stitches. This is an attractive stitch used for appliqueing, monogramming, and bartacking. Whenever you are using this stitch, it is well to remember to loosen the tension of the top thread slightly. The wider stitch you make, the looser the tension should be.

If you are stitching on a very soft fabric, it is well to use a backing of tissue paper or interfacing for a well formed stitch. Puckering of the material will be eliminated and the bobbin thread will not be visible on the right side of the fabric.

As with all special stitches, it is best to make a sample on your fabric before starting the design on the garment.

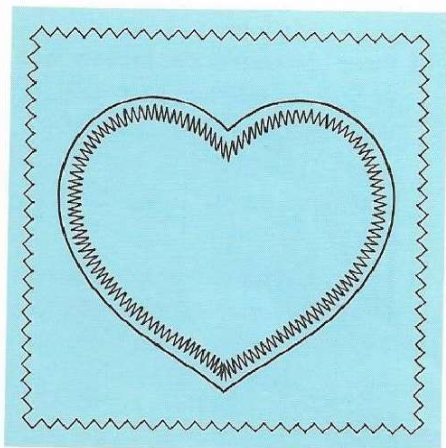

APPLIQUEING

SETTINGS:

Same as with Satin Stitching

Select an applique design to be applied to your garment and baste it in place. Satin stitch around the raw edge of the applique completely covering the edge. You may want to do this with a contrasting color of thread or self color.

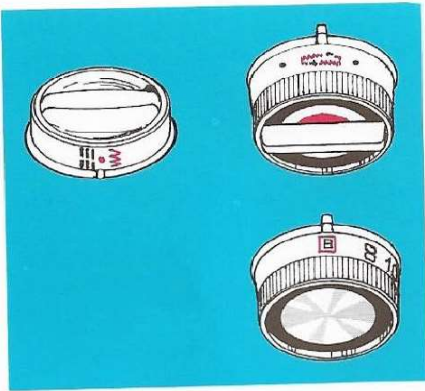

BUTTONHOLING

SETTINGS:

Special Stitch Dial — 

Special Stitch Variegator — Red mark on top

Stitch Width Control — 

Stitch Length Control — 

Buttonhole Foot

Mark your buttonholes on garment you are sewing. Set the controls of the machine as indicated above.

The markings on the left side of the buttonhole foot will enable you to make buttonholes of identical size when sewing a series. Markings are 1/8" apart, with the maximum length of 1-1/8". After determining the length buttonhole desired, slide the foot so that red arrow points to same mark on left side of foot at start of each buttonhole. (Be sure to make a sample buttonhole to verify size needed).

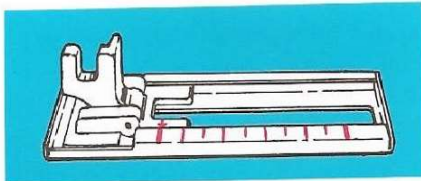

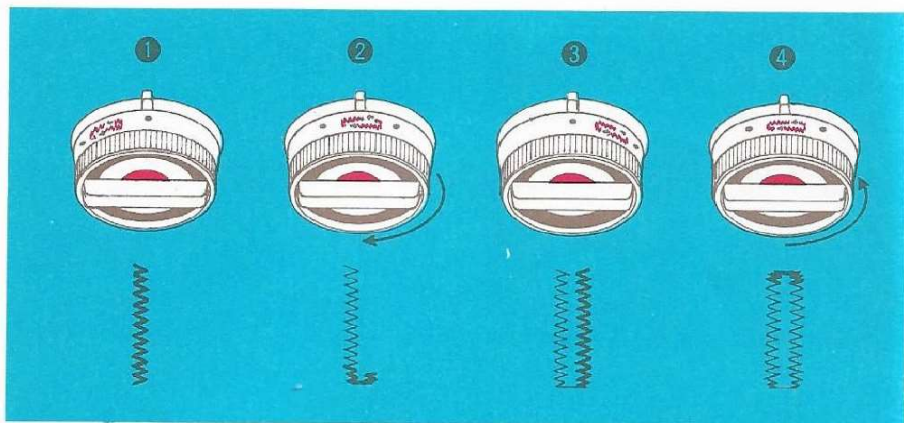

1. Let the needle pierce the fabric at the marked top end of the buttonhole. Slide presser foot so arrow points to desired length (1-1/8" buttonhole is set in illustration of foot above.) Lower the buttonhole presser foot. Start with Stitch Width-Buttonhole Control set as pictured in Fig. 1 above.
2. Stitch forward until you reach the marked end of the buttonhole. While maintaining a slow constant speed, turn the Stitch Width-Buttonhole Control clockwise (Fig. 2) until it stops as shown in Fig. 3 above.
3. You will then sew in reverse forming the second side of the buttonhole.
4. After sewing back to the beginning of the buttonhole, turn the dial slowly back to the first buttonhole position. (See Fig. 4.)

Note: All buttonholes should be made with an interfacing of tissue paper or interfacing fabric between the layers of garment. Always make a practice buttonhole on a scrap of the fabric you are sewing.

BUTTON SEWING

SETTINGS:

Special Stitch Dial — 

Special Stitch Variegator — Red mark on top

Darning Plate

Zigzag Stitch Foot

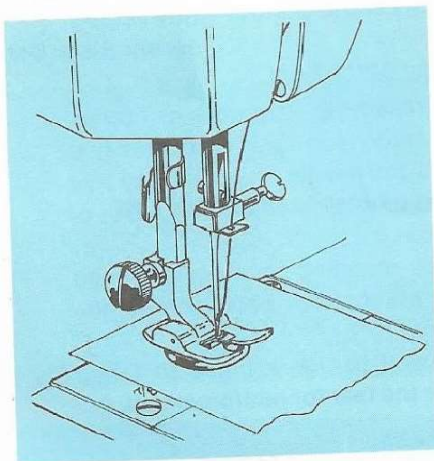

1. Align two holes of button evenly with slot of presser foot and lower foot to hold the button securely.
2. Turn hand wheel manually until needle point is just above button.
3. Adjust stitch width control so needle will enter one hole of the button.
4. Turn hand wheel again by hand so needle enters second hole. Readjust stitch width if necessary. Stitch a number of times.
5. Finish sewing with an extra two inches of thread remaining. Draw these threads to reverse side of garment and tie.

BAR TACKING

SETTINGS:

Special Stitch Dial — 

Special Stitch Variegator — Red mark on top

Stitch Width Control — 2 to 5

Stitch Length Control — 

Zigzag Stitch Foot

This stitch is similar to a very short satin stitch and is used to reinforce points of strain such as corners of pockets and straps on lingerie.

Sew 4 to 6 zigzag stitches.

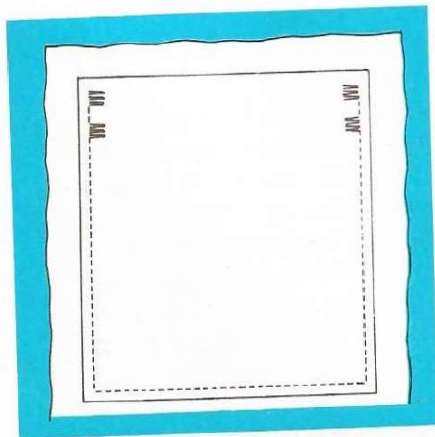

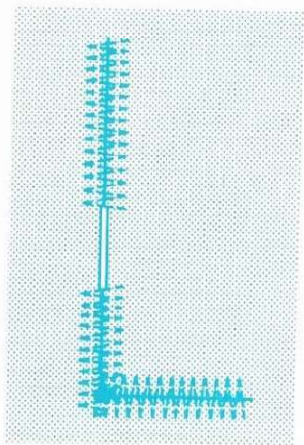

MENDING

SETTINGS:

Special Stitch Dial—

Special Stitch Variegator—Red mark
on top

Stitch Width Control—4 to 5

Stitch Length Control—Any setting
except Black Dot

Zigzag Stitch Foot

To repair a straight or three-cornered tear, position the tear under the needle in such a way that the stitching catches both sides of the tear.

When mending a three-cornered tear, stitch from each end to the center.

It is well to use a piece of fabric under the tear for reinforcement.

DARNING

SETTINGS:

Special Stitch Dial—

Special Stitch Variegator—Red mark
on top

Stitch Width Control—Red Dot

Darning Plate

No Presser Foot

Remove presser foot, stretch fabric between embroidery hoops with hole centered. Draw the bobbin thread up through the fabric by holding the top thread and taking one stitch at the spot where you wish to start darning. Lower the presser bar. Start sewing at a slow to medium speed. Move the fabric back and forth with a steady rhythm to cover the darning area.

When it is covered, turn the fabric and sew another layer of stitching across the first layer of stitching.

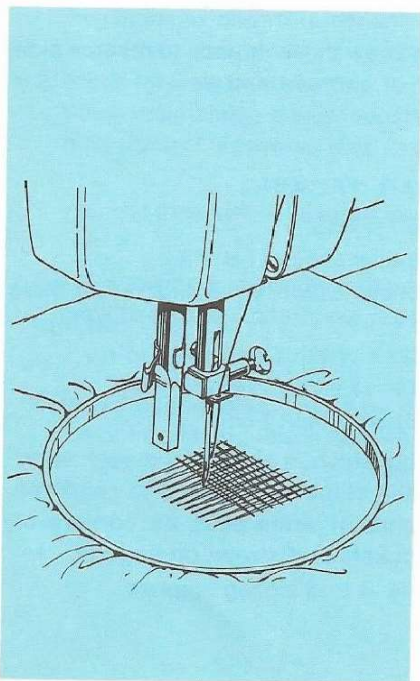

ZIPPER APPLICATION

SETTINGS:

Special Stitch Dial — III 

Special Stitch Variegator — Red mark on top

Stitch Width Control — Red Dot

Stitch Length Control — 10 to 12

Zipper Foot

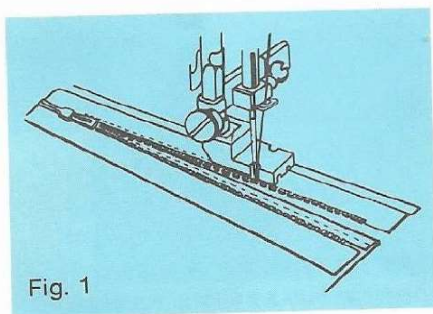

Fig. 1

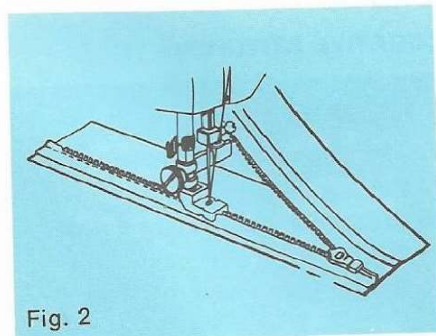

Fig. 2

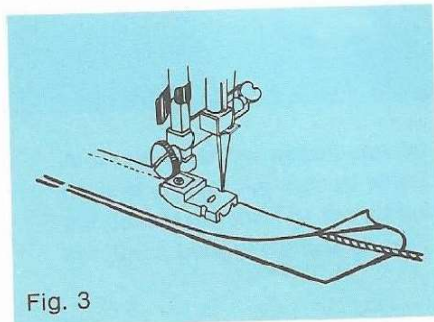

Fig. 3

REGULAR ZIPPER

The foot is adjustable for use on the right or left side of the needle when sewing the regular type of zipper. Adjust the foot so the needle clears the side notch on the foot. See Fig. 1. Carefully follow directions given on the zipper package.

INVISIBLE ZIPPER

Adjust the foot so the needle is sewing through the center hole of the foot and one groove of the foot is riding on the teeth of the zipper. See Fig. 2. Follow the zipper manufacturer's instructions. After zipper has been inserted, finish sewing seam by shifting foot to side position sewing through side notch.

CORDING

Foot can also be used to make cording for slipcovers etc. Cover a cord with a strip of bias fabric and sew as shown in Fig. 3.

DECORATIVE STITCHES

The stitches shown below are decorative stitch pattern, useful to decorate your garments. These stitches are special stitches built in to the machine for your quick selection.

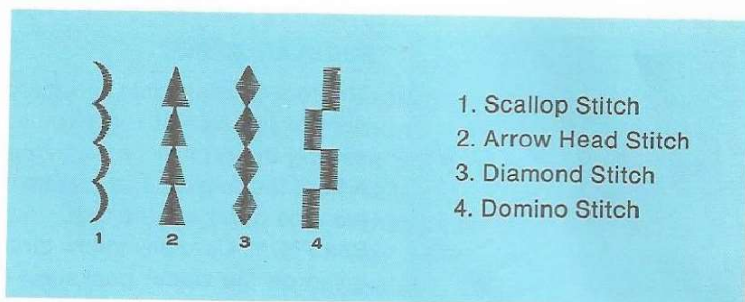

THINGS TO REMEMBER WHEN DECORATIVE STITCHING

1. Set each controls at required settings.
2. Reduce the top thread tension slightly.
3. To start decorative pattern at its beginning, stitch until a complete unit is obtained by using a scrap of the fabric.
4. Start with a full bobbin and plenty of thread on the spool to avoid running out of thread in the middle of your pattern.
5. On a very soft fabric you may want to use a tissue paper backing or organdy that can be cut away.

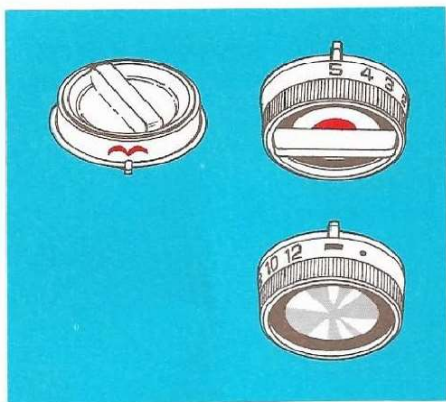

SCALLOP STITCH SETTINGS:

- Special Stitch Dial — 
- Special Stitch Variegator — Red mark on top
- Stitch Width Control — Any number 3 to 5
- Stitch Length Control — 
- Zigzag Stitch Foot

A speedy and decorative way of handling a raw edge is by using the Scallop Stitch. Simply sew along the raw edge of the fabric and trim close to the outside of the stitching.

This stitch is also attractive when decorating a collar or down the front of a blouse, around a cuff or finish on the edge of a cocktail apron.

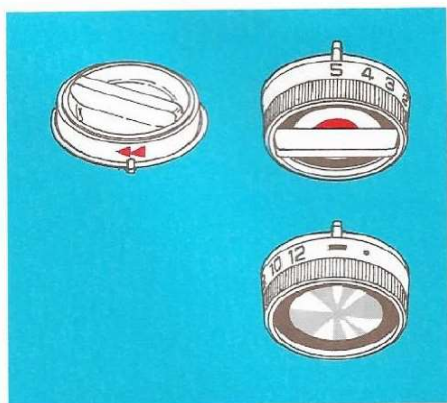

ARROW HEAD STITCH SETTINGS:

- Special Stitch Dial — 
- Special Stitch Variegator — Red mark on top
- Stitch Width Control — Any number 3 to 5
- Stitch Length Control — 
- Zigzag Stitch Foot

A series of arrow heads can be used to accent your sewing. Individual pattern unit is also a good stitch to reinforce the point of strain. Use it on the pocket corner. For the stimulated arrow head pattern, you must always set Stitch Length Control at  setting.

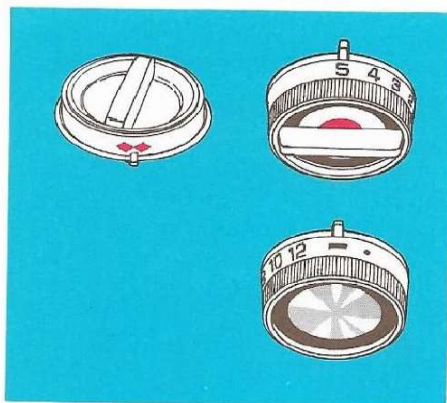

DIAMOND STITCH SETTINGS:

Special Stitch Dial — ◆◆

Special Stitch Variegator — Red mark
on top

Stitch Width Control — Any number
3 to 5

Stitch Length Control — ■

Zigzag Stitch Foot

This is a series of diamond patterns and is used to add professional touch to your sewing, such as blouses and dresses.

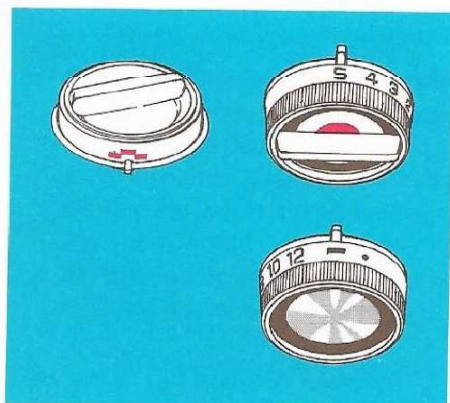

DOMINO STITCH SETTINGS:

Special Stitch Dial — ◆◆

Special Stitch Variegator — Red mark
on top

Stitch Width Control — Any number
3 to 5

Stitch Length Control — ■

Zigzag Stitch Foot

This pattern is attractive for the bottom lines of cooking apron and children's skirt.

FREE-ARM SEWING

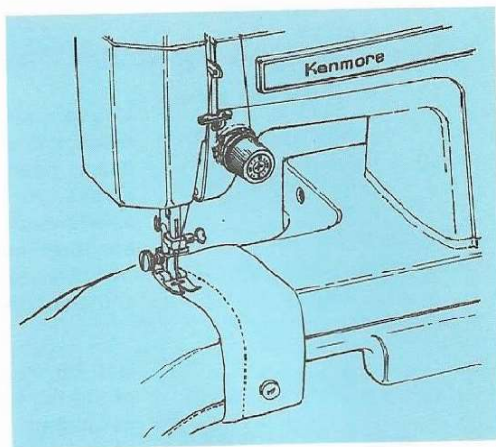

This sewing machine can be used like a flat bed machine, but easily converts to free arm machine by removing the table.





The free arm enables you to sew tubular types of pieces more easily. Just slip the sleeve or pants leg on the free arm as shown above.

You will find many uses for this free arm feature such as:

1. Mend elbows and knees of garments more easily.
2. Sew in sleeves more easily. This is especially true when sewing smaller garments.
3. Applique, embroider or hem around edges of cuffs or pants legs.
4. Sewing in elastic casings in skirts or pants at the waistline.

GUIDANCE For Your Selection of the Best Kind of Stitch For Your Stretch Fabrics.

Specially for Stretch

 <p>STRAIGHT STRETCH</p>	<p>U S E</p> <p>Use on stretch knit fabrics. Use to repair knit ready made garments where seams need give. Use to seam areas of stress in childrens and adults sportswear—crotch seams, armholes, etc. Sew center seam of men's neck ties. Sew any seam that is on the bias and must give.</p>
 <p>RICK-RACK STRETCH</p>	<p>Use for all-purpose heavy duty sewing of stretch fabrics. Same usages as that of zigzag stitch on lighter weight stretch fabrics.</p>
 <p>SMOCKING</p>	<p>Use on children's wear, baby clothes and lingerie.</p>
 <p>OVERCAST STRETCH</p>	<p>Use on crotch seams, waistband and seam finishes in shorts and slacks, ski wear and swimwear construction.</p>

Useful Stitches with Stretch Applications

 <p>PLAIN ZIGZAG</p>	<p>U S E</p> <p>Use for all-purpose stretch sewing, seam finishing, edge finishing, or attaching stretch laces.</p>
 <p>BLIND STITCH</p>	<p>Overcast seam finishing on all types of stretch fabrics. Flexible blind hemming.</p>
 <p>MENDING</p>	<p>To repair a straight or three-cornered tear.</p>
 <p>SCALLOP STITCH</p>	<p>Use for attaching girdle panels and applying stretch laces.</p>

Fabric	Special Stitches to Use	Special Notions to Use
Nylon Tricot	Shallow zig zag Short straight stitch Overcast stretch Blind hem	"Q" Needle Polyester, nylon or dacron core thread.
Stretch Terry Cloth	Straight stretch Overcast stretch Zig zag	Mercerized thread Polyester, nylon or dacron core thread. "Q" needle
Leather	Straight or simple zigzag	Mercerized or sliik thread Size 14 needle 1/2 pressure on presser foot
Stretch knit for Swimwear, Skiwear, Girdles	Straight stretch Overcast stretch Blind hem Zig zag stretch Elastic stretch Mending Scallop stitch	Polyester, Nylon or dacron core thread. "Q" needle Lace seam tape Pre-shrunk zippers

New fabrics are coming on the market all the time. Remember that soft fabrics may need to be stabilized a little. This is especially true when buttonholing or satin stitching as the stitches are so close together. A backing of tissue paper or interfacing may assist you in your sewing. The paper may be torn away and the interfacing cut away after sewing. Check your fabric by making practice samples on a scrap of fabric before sewing on your garment.

Checking Performance Problems WHAT TO DO

PROBLEM	PROBABLE CAUSE	CORRECTION
Irregular Stitches	<p>Incorrect size needle. Improper threading. Unusual thread such as imported thread or buttonhole twist. Loose upper thread tension. Pulling fabric. Light pressure on presser foot. Loose presser foot. Unevenly wound bobbin. Nicks or burrs on shuttle. Nicks or burrs at hole of needle plate.</p>	<p>Choose correct size needle for thread and fabric. Rethread machine. Use "Q NEEDLE"™.</p> <p>Tighten upper thread tension. Do not pull fabric; guide it gently. Increase pressure on presser foot. Reset presser foot. Rewind bobbin. Replace shuttle, or polish off burrs completely. Replace needle plate, or polish off burrs completely.</p>
Breaking Needle	<p>Pulling fabric. Incorrect size needle. Incorrect setting of needle. Loose presser foot.</p>	<p>Do not pull fabric; guide it gently. Choose correct size needle for thread and fabric. Reset needle. Reset presser foot.</p>
Bunching of Thread	<p>Upper and lower threads not drawn back under presser foot before starting seam.</p>	<p>Draw both threads back under presser foot and hold for first few stitches.</p>
Puckering	<p>Incorrect thread tension(s). Light pressure on presser foot. Using two different sizes or kinds of thread. Bent or blunt needle. Loose presser foot. Fabric too sheer or too soft.</p>	<p>Reset thread tension(s). Increase pressure on presser foot. Upper thread and bobbin thread should be same size and kind. Insert new needle. Reset presser foot. Use underlay of tissue paper.</p>

PROBLEM	PROBABLE CAUSE	CORRECTION
Skipping Stitches	<p>Incorrect size needle. Certain knits and synthetic. Unusual threads such as imported thread or buttonhole twist. Bent or blunt needle. Incorrect setting of needle. Tight upper thread tension. Light pressure on presser foot.</p>	<p>Choose correct size needle for thread and fabric. Use "Q NEEDLE"™. Use "Q NEEDLE"™. Insert new needle. Reset needle. Loosen upper thread tension. Increase pressure on presser foot.</p>
Breaking Upper Thread	<p>Starting to stitch too fast. Improper threading. Tight upper thread tension. Incorrect size needle. Sharp eye in needle. Nicks or burrs on shuttle. Nicks or burrs at hole of needle plate.</p>	<p>Start to stitch at a medium speed. Rethread machine. Loosen upper thread tension. Choose correct size needle for thread and fabric. Insert new needle. Replace shuttle, or polish off burrs completely. Replace needle plate, or polish off burrs completely.</p>
Breaking Bobbin Thread	<p>Improper bobbin case threading. Tight bobbin thread tension. Lint in bobbin case or shuttle.</p>	<p>Check bobbin case threading. Loosen bobbin thread tension. Clean bobbin case and shuttle.</p>
Fabric not Moving	<p>Darning plate attached. Light pressure on presser foot. Threads knotted under fabric.</p>	<p>Remove darning plate. Increase pressure on presser foot. Place both threads back under presser foot before beginning to stitch.</p>
Machine Jamming Knocking Noise	<p>Thread caught in shuttle.</p>	<p>Disassemble and clean shuttle.</p>

Cleaning Your Machine and Keeping It Clean

It takes a little time—and very little effort—to keep the essential parts of your sewing machine in finest working order. For the easy maintenance described on these pages, you may want to buy the special sewing machine oil and brush available in the sewing machine department of your nearest Sears store.

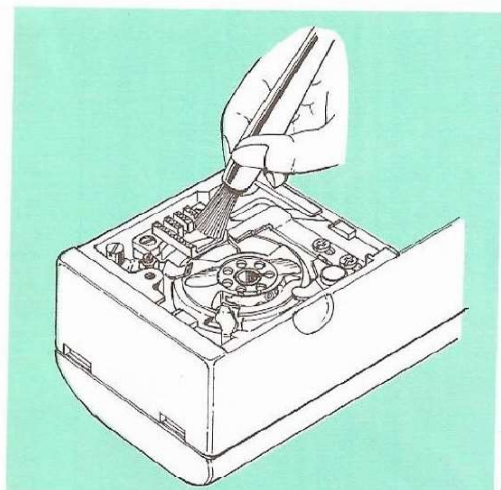

The small brush can be used to clean in and around the feed dogs and shuttle area to remove accumulated dust and lint. This is specially important when you're working with knits and fabrics with nap that tend to shed more than woven fabrics.

Cleaning shuttle area. On rare occasions, you may want to clean the shuttle area. Just follow these simple steps....

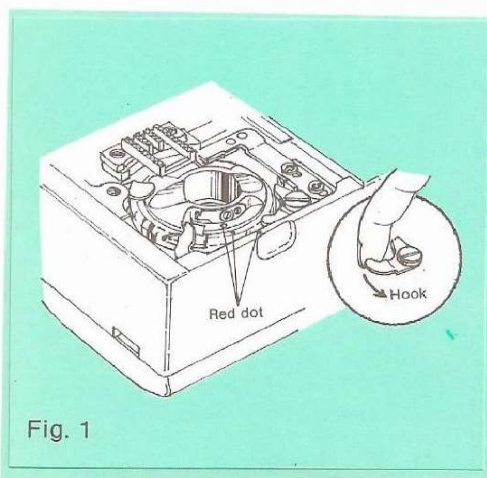

Fig. 1

1. Turn hand wheel toward you to raise needle to highest position.
2. Remove bobbin cover plate ...just lift up the front and it slips right out.
3. Loosen two screws of needle plate and remove needle plate.
4. Turning hand wheel slowly toward you, align three red dots in line. Move hook toward you with your finger. Fig. 1.

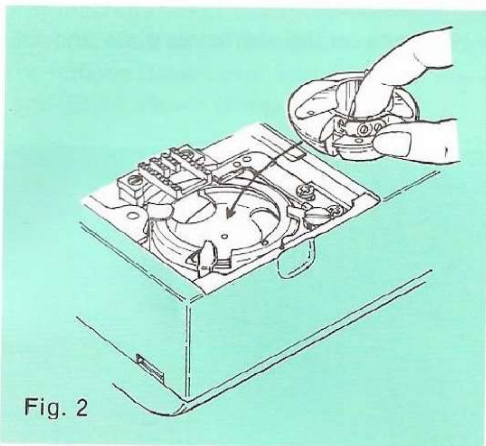

Fig. 2

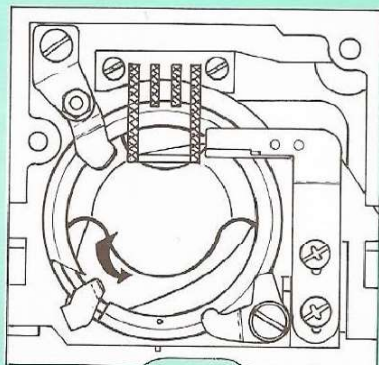

Fig. 3

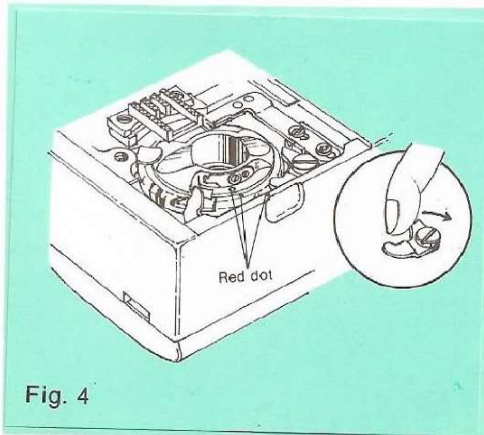

Fig. 4

5. Lift up on the front edge of bobbin case and pull bobbin case out. Fig. 2.

Then clean shuttle with small brush and put a drop of oil on bottom of shuttle. Fig. 3.

Don't over-oil (Reminder: don't use household oil...use sewing machine oil.)

6. Replace bobbin case realigning the three red dots. Move hook back to original position holding case in place. Fig. 4.

OILING UNDER TOP COVER PLATE

Remove the top cover plate to oil points indicated.

To remove the cover plate, unscrew two bolts on the top cover plate and lift cover plate.

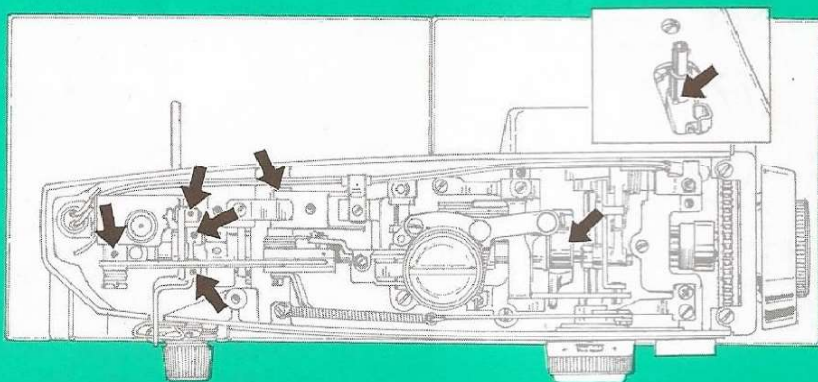

OILING UNDERSIDE

Tilt machine head back and remove base cover and free arm cover to oil points indicated on underside of machine.

To remove base cover and free arm cover, remove screws (A), (B), (C), (D) and (E) as shown below.

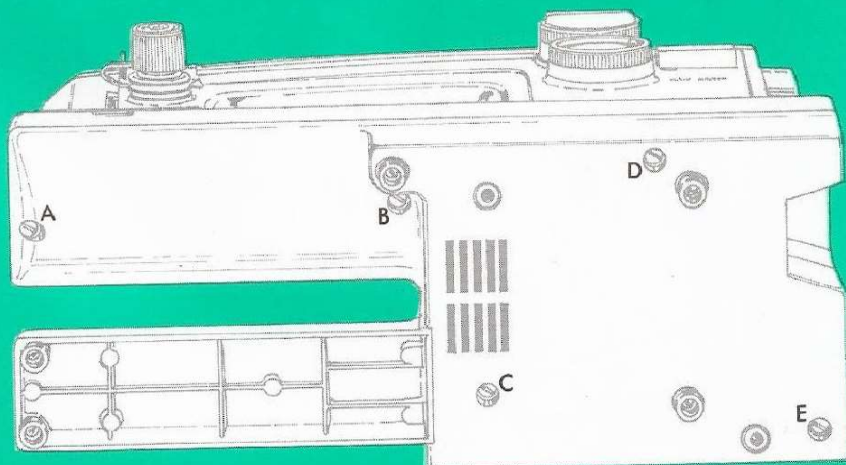
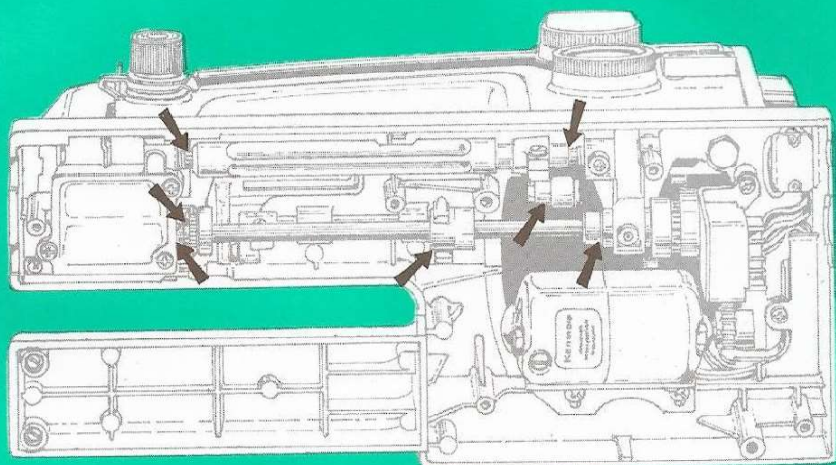

OILING IN FACE COVER PLATE

Swing hinged face cover plate open and oil points indicated.

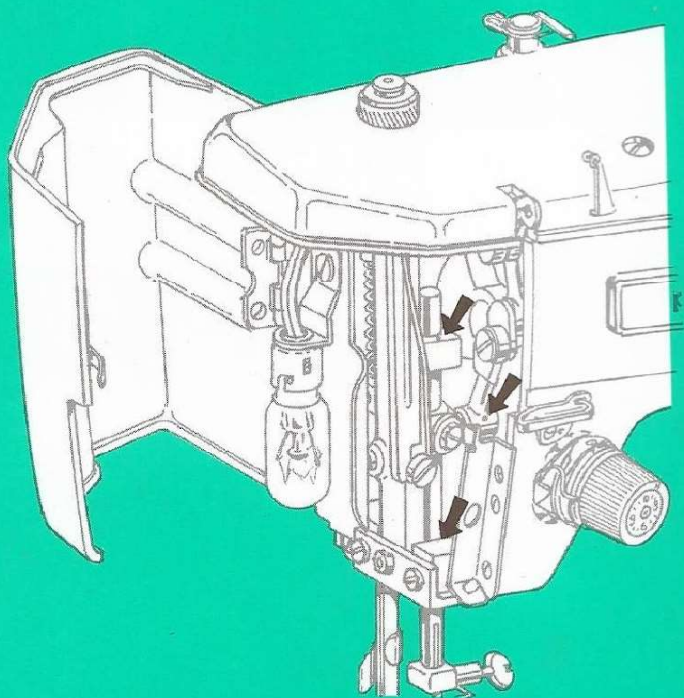

PART LIST

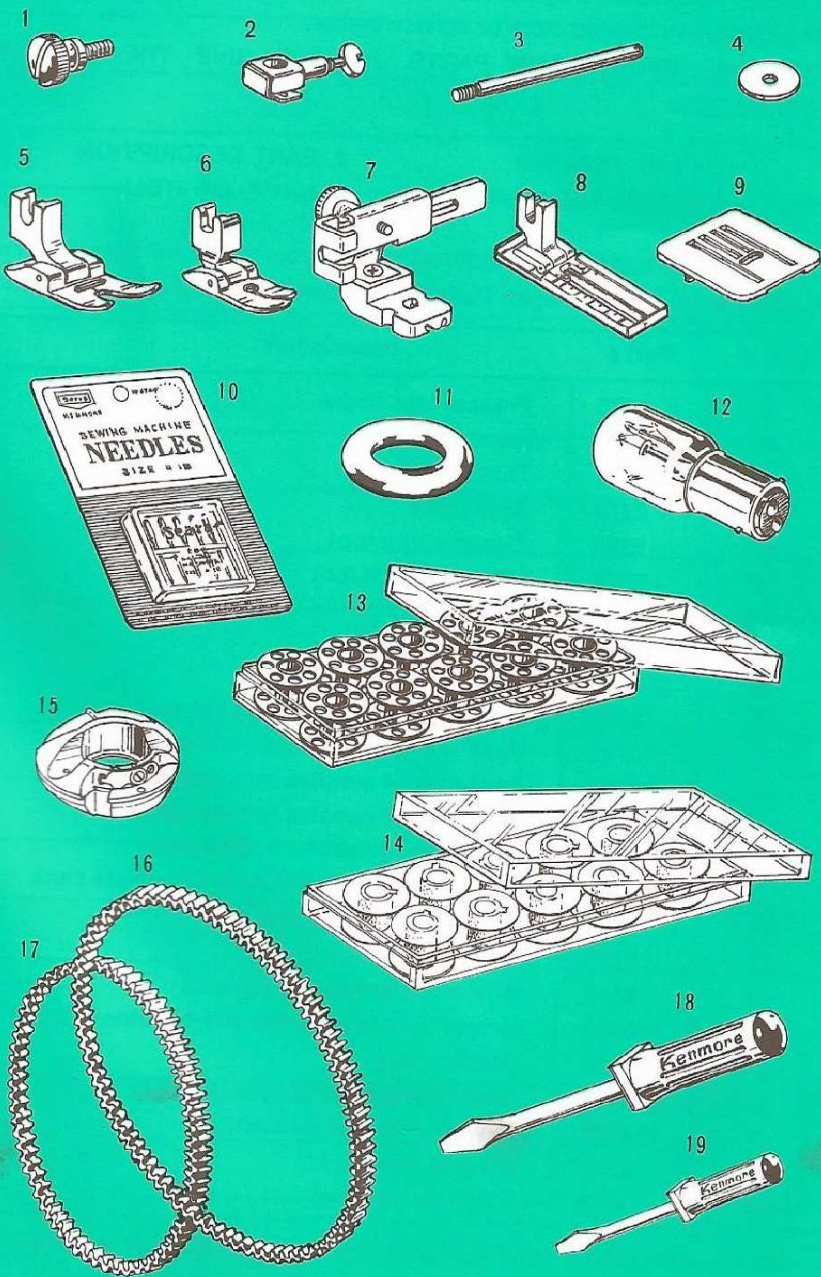

PART LIST

All parts listed herein may be ordered from any Sears, Roebuck and Co. or Simpsons-Sears Limited store or service center.

WHEN ORDERING REPAIR PARTS, ALWAYS GIVE THE FOLLOWING INFORMATION:

- | | |
|-----------------|---------------------|
| 1. PART NUMBER | 2. PART DESCRIPTION |
| 3. MODEL NUMBER | 4. NAME OF ITEM |

If the parts you need are not stocked locally, your order will be electronically transmitted to a Sears Repair Parts Distribution Center for expedited handling.

Ref. #	Part #	Description
1	135	Presser foot screw
2	214203	Needle clamp
3	231008	Thread spool pin
4	2273	Nylon disc
5	9363	Zigzag stitch foot
6	6873	Straight stitch foot
7	6757	Zipper foot
8	214369	Buttonhole foot
9	214763	Darning plate
10	*6740	Pack of # 9 needles in orange pack
	*6741	Pack of # 11 needles in yellow pack
	*6742	Pack of # 14 needles in red pack
	*6743	Pack of # 16 needles in green pack
	*6744	Pack of # 18 needles in blue pack
	*6746	Pack of "Q NEEDLES"™ in chocolate pack
11	1939	Bobbine winder rubber ring
12	6797	Light bulb
13	*6862	Box of metal bobbins (10 pcs)
14	*6868	Box of light weight plastic bobbins (10 pcs)
15	214718	Bobbin case
16	200885	Sewing machine belt (long)
17	214756	Sewing machine belt (short)
18	3015	Large screwdriver
19	3016	Small screwdriver

*These parts are not furnished with the machine, but may be ordered.
(See above ordering information)